

C-220 STEREO DISC EQUALIZER *Accuphase*

(TYPE A)

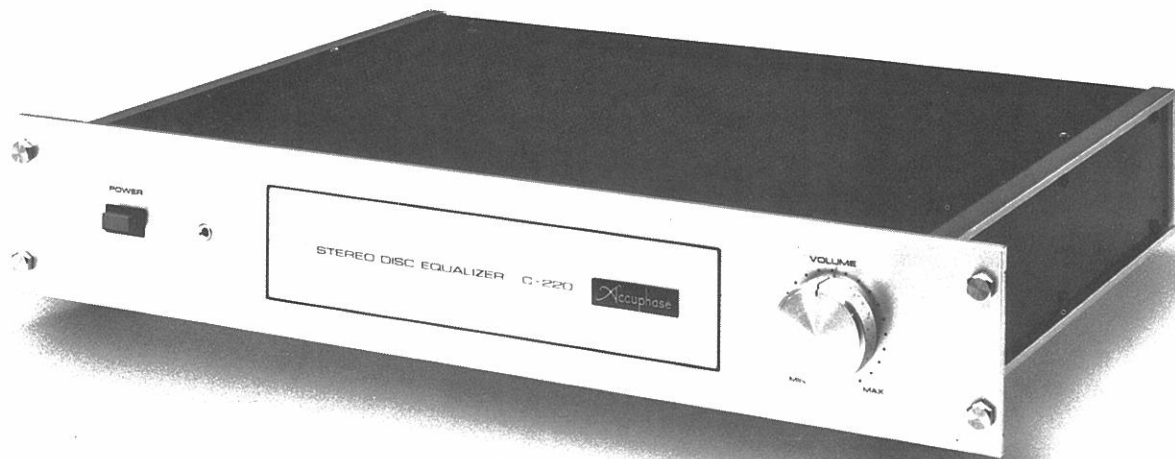

(TYPE B)

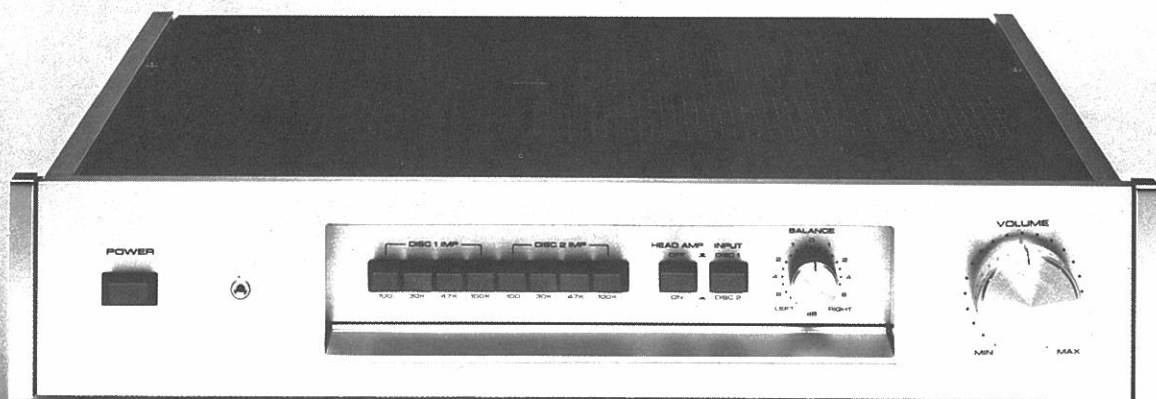

Accuphase C-220

The unlimited possibilities of phonograph record reproduction become incredibly apparent with each new improvement in the quality of sound reproducing systems. This is noticeable especially with recent cartridge and speaker system improvements, when backed by top grade amplifiers. Details of music heretofore completely absent can now be recreated superbly with such a system that gives new stereophonic breadth and depth to disc reproduction, while retaining left-right image positions faithfully.

With such possibilities opening up in disc reproduction, it is natural for high fidelity enthusiasts to seek ALL the musical information that is stored in their disc grooves, and enjoy the superb sound that contains the finer nuances of music.

The Accuphase C-220 DISC EQUALIZER was created to meet the requirements of just such true high fidelity enthusiasts. It is the result of endless listening tests to ensure clear sound of outstanding quality, and incorporates today's highest level audio technology. It, therefore, ensures top grade phono equalization performance, and provides correct de-emphasis for a faithful, flat frequency response.

This unit does not contain any AUX or TAPE inputs since design priority was focused, without any compromise, on a special disc equalizer pre-amplifier of the highest quality. It was intended from the outset to be used together with a preamplifier that is already a part of your high fidelity system.

1. General Outline

(a) How to reproduce sources other than discs.

Although this unit has no special AUX or TAPE inputs, it is provided with a separate input to accommodate these other sources which connect directly to the power amplifier when the POWER switch of the C-220 is turned OFF.

Figure 1. shows how this is done. The output of the preamplifier in your possession to which a Tuner or Tape Recorder, or both, are connected, is routed to the EXT PREAMP INPUT of this unit.

These sources then connected directly to the power amplifier automatically, for radio reception or tape playback, when the POWER switch of this unit is turned OFF.

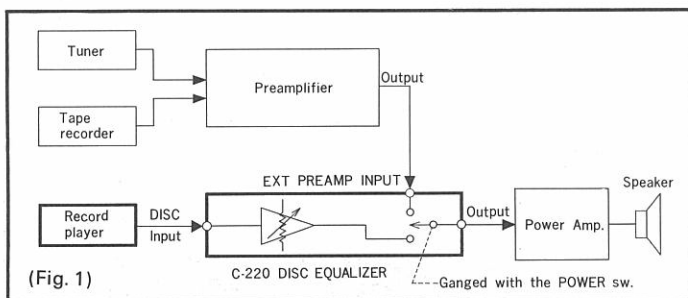

Figure 2. shows how the outputs of a Tuner and Tape recorder that are equipped with their respective level controls can be routed for direct connection to the power amplifier through the EXT PREAMP INPUT jack of this unit when its POWER switch is turned OFF.

In this case, the desired source must first be selected with the selector switch arrangement, as shown.

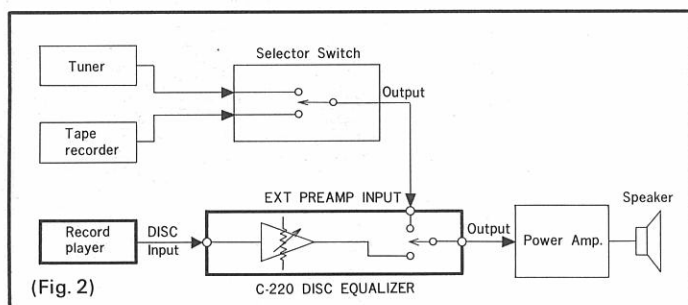
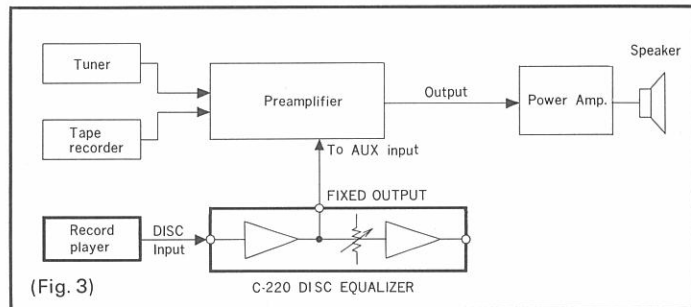

Figure 3. shows how the FIXED OUTPUT from this unit can be connected to the AUX input of the preamplifier or control center that you have for tone control and acoustic compensation.

In this case, the equalizer amp section of your preamplifier is employed instead, but it is, of course, possible to use the head amplifier section of the C-220.



(b) Built-in Head Amplifier helps boost total gain to 86dB.

This Stereo Disc Equalizer which is consisted of a head amplifier with a 26dB gain for connecting Moving Coil (MC) cartridges, and an equalizer amplifier with a 60dB gain has a total gain of 86dB, the highest figure of any similar component. Therefore, it is fully capable of providing any gain required for any type of cartridge with any power amplifier combination.

(c) Single Tone Arm sufficient for both MC and MM cartridges.

Because of the large noise created during switching, it is not practical with most preamplifiers that have a built-in head amp, to use both MC and MM (Moving Magnet) type cartridges with a single tone arm.

It is the usual practice with such preamps to use separate tone arms which is most inconvenient.

The C-220 employs a relay control to switch the head amplifier in or out of the amplification lineup noiselessly, as required. It utilizes an electronic circuit which induces a time lag and activates a muting relay that cuts off the output and eliminates the switching noise. This makes it possible to use both MC and MM type cartridges with a single tone arm, which is a great convenience advantage. An exceptionally excellent and durable relay with very low contact resistance was carefully selected for this important function.

2. Circuit Features

(a) Symmetrical Push-Pull Class-A amplification in all driver stages.

An improved version of the symmetrical push-pull circuit which Accuphase first developed and introduced to the audio world in its Models P-300 and C-200 is used in every driver stage.

The special feature of this circuit is its superior inherent low distortion characteristics even before negative feedback (NFB) application, so that its final low distortion performance is outstanding. Distortion ratio of each amplifier stage is less than 0.001% at 1kHz which is close to the measurable limit.

Moreover, this circuit ensures very stable operation against line voltage fluctuations.

(b) Every DC amplifier stage use Class-A amplification.

No capacitors are used in the NF loop of the DC, Class-A amplifiers that are used in every stage, as well as in the head amplifier. Highest grade sound of outstanding quality is also due to the most careful selection of parts, and rejection of those with adverse sound imparting qualities.

(c) New RET transistors used in head amplifier.

Newly developed Ring Emitter Transistors (RETs) for superior high frequency power amplification are employed at the signal input of the head amplifier to comprise a push-pull, differential DC amplifier that is operated as a Class-A amplifier with a complementary-symmetry output. This new RET is consisted of 100 low input signal transistors working in parallel with the ballast resistors at the emitters constructed by its diffused layer. It thus retains the superior high frequency characteristics of low amplification factor transistors, while providing the advantage of very high power amplification.

This unit has achieved a remarkably low noise rating by employing these new RETs at the input of the head amplifier where signal level is extremely low. Due to their excellent high frequency characteristic and parallel structure efficiency, the equivalent input noise resistance is considerably lower than that of conventional transistors or FETs. These RETs are also the major factor for the very low circuit impedance, as well as the low NFB input side impedance of the differential amplifier since they can deliver large signal currents to amplifying elements.

The S/N ratio of the head amplifier at its rated input of 0.1mV is 74dB which approaches the theoretical limit.

Another significant feature of this head amplifier is the very stable center voltage of its input circuit. This has eliminated the need for an input capacitor which can greatly harm sound quality.

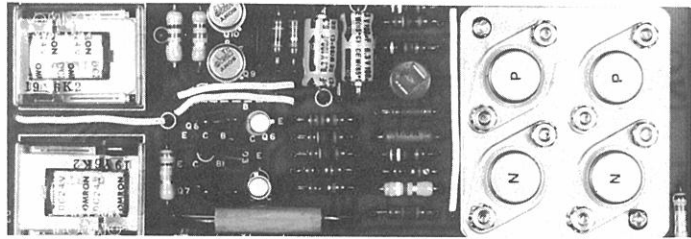
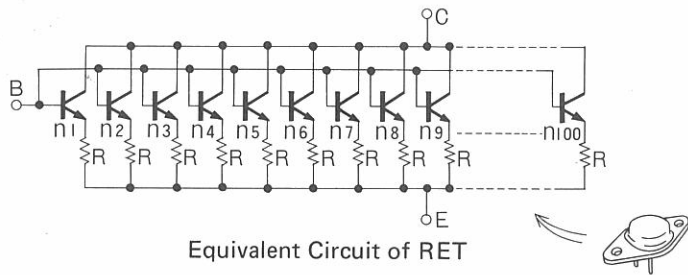

(d) The Equalizer Amplifier section features Direct-Coupled input and RET complementary-symmetry output.

The Equalizer Amplifier section features a direct-coupled input circuit that is comprised of a symmetrical, push-pull differential amplifier and an FET buffer amplifier. The output is a complementary-symmetry circuit which employs RETs for superior high frequency performance. Also the RETs ensure low impedance output by delivering large driving currents and help to lower the impedance of the NF loop. As a result the S/N ratio of the equalizer amplifier at its rated input of 2mV, as actually measured, is 86dB which is the theoretical limit.

(e) Constant Voltage Power Supply assures low impedance at all frequencies.

When we consider the problems of non-linear crosstalk distortion, or those of instabilities in seeking high gain that must be solved in high fidelity design, we must acknowledge that the power supply of the preamplifier, rather than that of the power amplifier, is more important. The power supply of this unit employs a DC servo amplifier to achieve complete stability. Moreover, very careful attention was given to holding impedance for all frequencies as low as possible, not only throughout the aural range, but also from DC to the ultra sonic frequencies. Any adverse effect on sound quality that could possibly be faulted to the equalizer's power supply was completely eliminated through repeated aural tests and appropriate countermeasures.

3. Sub-Panel used for all function controls except Volume Control and Power Switch.

The function controls of this unit include, Volume Control, Balance Control, Disc 1 – Disc 2 Selector Switch, Head Amplifier ON/OFF Switch, Disc 1 Input Impedance Selector, Disc 2 Input Impedance Selector and Power Switch. Except for the Volume Control and the Power Switch, all other function controls which are less apt to be used, have been placed in the sub-panel.

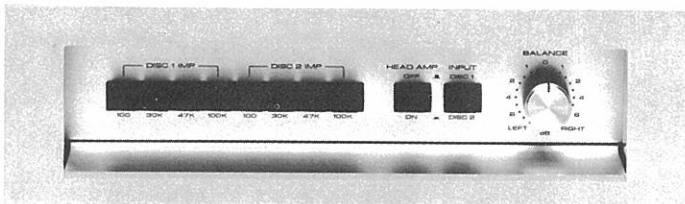

4. Available in Two Designs.

The C-220 is available in two design types: a 19-inch rack mount "A" type and a side plate "B" type which is designed to match the Accuphase P-300 and C-200.

5. CANNON XLR type connectors convenient for Commercial Use.

The C-220 is equipped with both ordinary RCA pin jack connectors, as well as Cannon XLR type connectors which permit locking and are convenient for commercial use.

Type A: Mountable on 19" standard rack

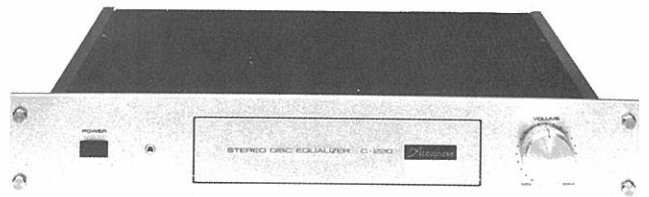

Type B: Front Panel designed to match P-300/P-250/C-200/T-100

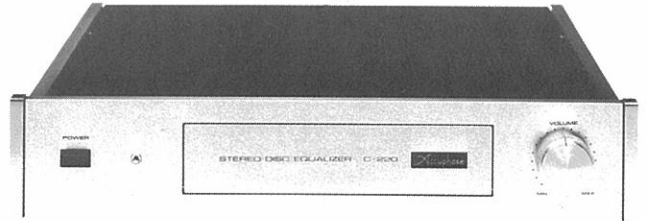

Rear Panel view

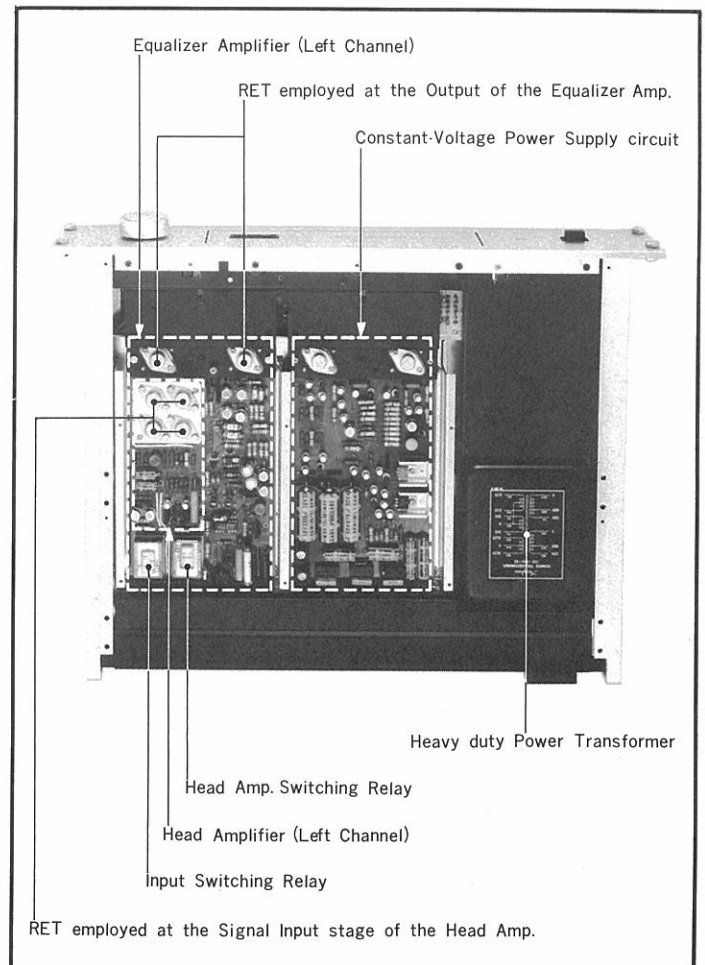

Accuphase C-220

GUARANTY SPECIFICATIONS

Performance Guaranty: Products of Accuphase guarantee specifications stated.

FREQUENCY RESPONSE :

±0.2dB, 20Hz to 20,000Hz

TOTAL HARMONIC DISTORTION :

0.01% at rated output level, 20Hz to 20,000Hz

INPUT SENSITIVITY AND IMPEDANCE:

DISC 1, 2 (HEAD AMP switch set to OFF); 2.0mV

Selector for 100-ohm, 30K-ohm, 47K-ohm and 100K-ohm

DISC 1, 2 (HEAD AMP switch set to ON); 0.1mV, 100-ohm fixed

OUTPUT LEVEL AND IMPEDANCE :

MAIN OUTPUT; 2.0V, 200 ohms at rated input with VOLUME control maximum

FIXED OUTPUT; 150 mV, 200 ohms

OUTPUT LOAD IMPEDANCE:

MAIN OUTPUT; 5 Kohms minimum

FIXED OUTPUT; 10 Kohms minimum

MAXIMUM INPUT LEVEL :

400mV RMS, without HEAD AMP, 0.01% THD at 1 kHz

20mV RMS, with HEAD AMP, 0.01% THD at 1 kHz

MAXIMUM OUTPUT LEVEL :

10V RMS at 0.01% distortion, 20Hz to 20,000Hz

HUM AND NOISE (at rated input, IHF A weighted)

85dB below rated output, without HEAD AMP

72dB below rated output, with HEAD AMP

VOLTAGE AMPLIFICATION (DISC INPUT to MAIN OUTPUT):

60dB, without HEAD AMP

86dB, with HEAD AMP

VOLUME CONTROL:

Tracking error; less than 1dB with control down to -60dB

BALANCE CONTROL:

Attenuation of LEFT or RIGHT channel by 0, -0.5, -1.0, -1.5, -2.0, -3.0, -4.0, -5.0, -6.0, -7.0dB, -∞

SEMICONDUCTOR COMPLEMENT:

109 Transistors, 16 FET's, 34 Diodes

POWER REQUIREMENT:

Voltage Selector for 100, 117, 220 and 240V 50/60Hz operation

Consumption 65 watts

DIMENSIONS:

(Type A) 482mm (19 inches*) wide, 82mm (3 - 1/4 inches) high, 345mm (13 - 9/16 inches) deep

* Mountable on 19" standard rack.

rack mount pitch; 50 mm (2")

rack inside horizontal measurement; 430 mm

(16 - 15/16")

(Type B) 445mm (17 - 1/2 inches) wide, 82mm (3 - 1/4 inches) high, 349mm (13 - 3/4 inches) deep

WEIGHT (Type A, B): 10.7 Kgs. (23.5 lbs) net, 15.2 Kgs. (33.4 lbs) in shipping carton

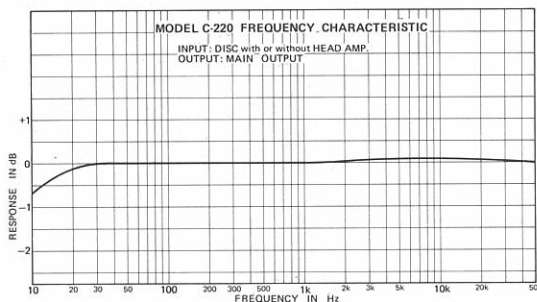
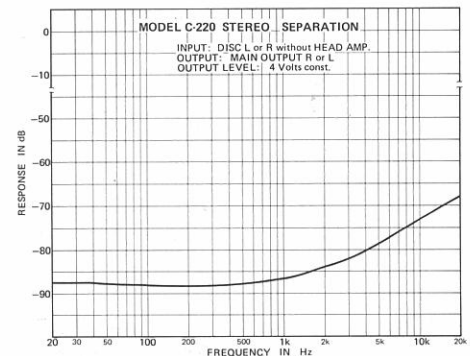
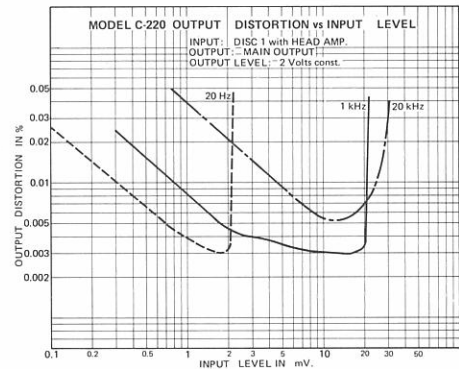
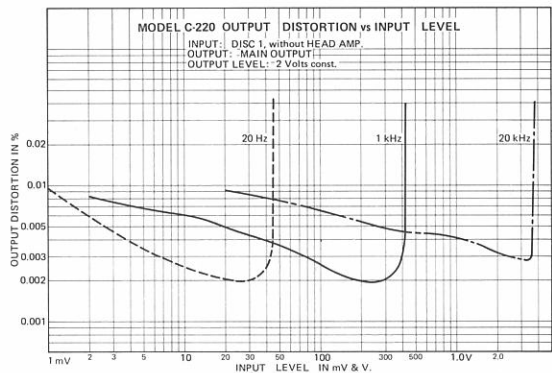
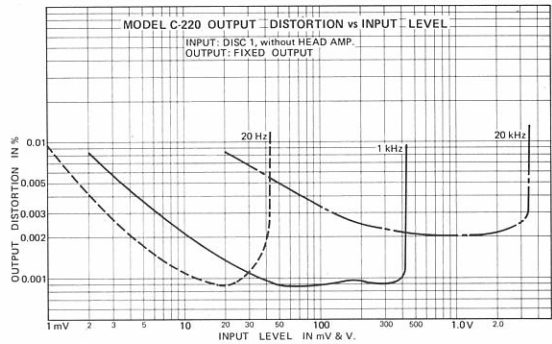

Accuphase
KENSONIC LABORATORY INC.